



TIANJIN GREWIN TECHNOLOGY CO.,LTD.

Web:www.grewin-tech.com WhatsApp:+86-13072088960

Email:salesmanager@grewin-tech.com

FLC-908D EHV cable sheath fault

Pin-pointer

© We reserve all right in this document and in the information contained within. Reproduction, use or disclosure to third partners without express authorization is strictly forbidden.
V 1.0

TIANJIN GREWIN TECHNOLOGY CO.,LTD.

Address: 2# MeiNian Plaza No.16 DongTing Road,Hexi Distr,300222,Tianjin China.

NOTICE

Thank you for choosing our devices.

Read the instruction carefully before using, specially pay attention to the security warning and tips.

Please don't maintain device by yourselves. Contact us if any breakdown or error.

Contact Info:

Web:www.grewin-tech.com

WhatsApp:+86-13072088960

Email:salesmanager@grewin-tech.com

1. GENERAL DESCRIPTION

1.1 GENERAL :

FLC-908D EHV cable sheath fault pin-pointer is an intelligent integrated with computer technology, digital signal processing and with innovative features, high-performance.



devices
technology

single core

It is mainly used for underground power cable (especially the

high voltage cable) metal sheath grounding fault accurately pinpointing, also can be used in the auxiliary pinpointing of core grounding fault (in the case of sheath have been destroyed).The FLC-908D EHV cable sheath fault pin-pointer can measure the resistance current in the fault cable through the current sensor in the well, and locate the fault point of the cable in sections. For a large number of cables laid on cable bracket in cable tunnel, the fault point can also be determined by measuring DC voltage with high voltage probe rod.

FLC-908D needs to be used in cooperation with FLC-900D/FLD-902D EHV cable sheath fault locator to complete the precise grounding fault pinpointing of EHV cable sheath.

1.2 FUNCTION FEATHER:

- Three pinpointing modes, suitable for different fault types:

Step-voltage pinpointing mode: indicate the fault point directly and quickly find the fault point.

Fault current pinpointing mode: Quickly find the fault point by measurement the resistance current in the fault cable.

HV rod pinpointing mode: Measure the DC voltage in the fault cable to find the fault point.

- High sensitivity and wide response range.
- Digital signal processing technology, direct display signal waveform, strong anti-interference ability.
- Automatic zero adjustment, counteract the effect of ground potential change.
- Built-in large capacity lithium ion battery pack, under voltage automatic shutdown, long time no operation automatic shutdown.
- Solid case, light weight and portable.

1.3 SPECIFICATION:

MODE	ACCESSORY	ACCURACY	MAX. SENSITIVITY	MAX.INPUT RANGE	DISPLAY
STEP-VOLTAGE	Step voltage probe	1%(±0.1mV)	0.1mV	±300V	Signal waveform, fault point direction
FAULT CURRENT PINPOINTING	Current sensor	1%(±1mA)	1mA	±1A	Signal waveform, fault current value
HV PROBE ROD PINPOINTING	Step voltage rod	<1%(10V-10kV)	1V(10-1kV) 10V(1kV-10kV)	±10kV	DC voltage
Other					
Built-in	18650 Lithium battery, standard 3.7V, 6.8Ah.				
Work status	Temperature :-10℃-40℃; Humidity 10-90%RH; Elevation <4500m				
Weight and volume	Volume: 220mm×125mm×55mm; Weight: 0.9kg				

2. DEVICE COMPOSITION:

Device main units includes receiver, step voltage probe (two pieces), current sensor, HV rod.

2.1 RECEIVER:



Fig.1 Receiver appearance

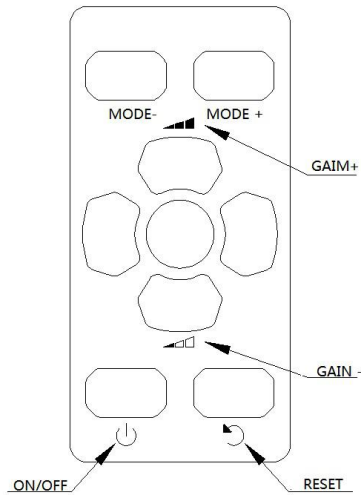

Fig.2 operation buttons

TIANJIN GREWIN TECHNOLOGY CO.,LTD.

Address: 2# MeiNian Plaza No.16 DongTing Road,Hexi Distr,300222,Tianjin China.

2.2 STEP VOLTAGE PROBE:

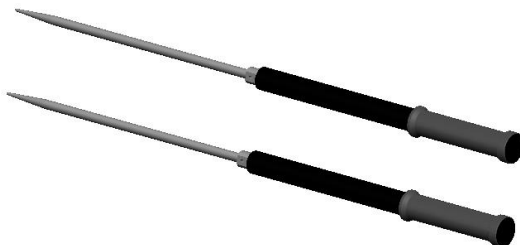

Fig.3 step-voltage probes

2.3 CURRENT SENSOR

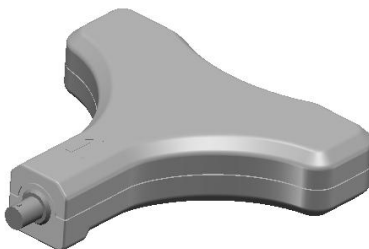

Fig.4 current sensor

2.4 HV ROD



Fig.5 HV rod

3. OPERATION METHOD

3.1 WORK PRINCIPLE:

As shown in Fig. 6, first, disconnect all the grounding points of the cable sheath. The output line of the reference phase of the FLC-900D/FLD-902D sheath fault locator should be removed, and the output line of the fault phase should be connected to the fault sheath.

Testing ground wire should be connected to the earth.

Press the DC/PULSE button to make the FLC-900D/FLD-902D operate in the pulse output state. The current is injected by the sheath and flows from the fault point to the ground and back to the signal source.

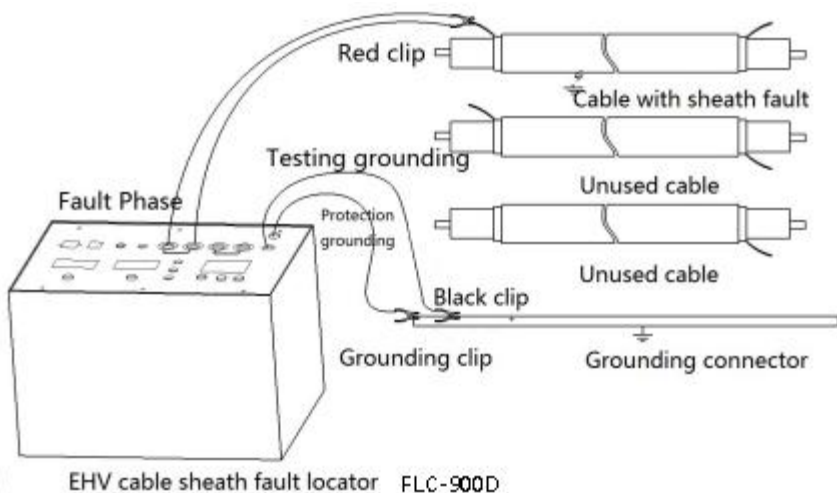

Fig.6 Wiring reference

In the vicinity of the fault point, the current flows into the earth in all directions from the damage point of the protective layer, and there is a potential difference between any two points on the ground, that is, the step voltage. By detecting the strength and direction of the step voltage, the

position of the fault point can be determined, as shown in Fig. 7.

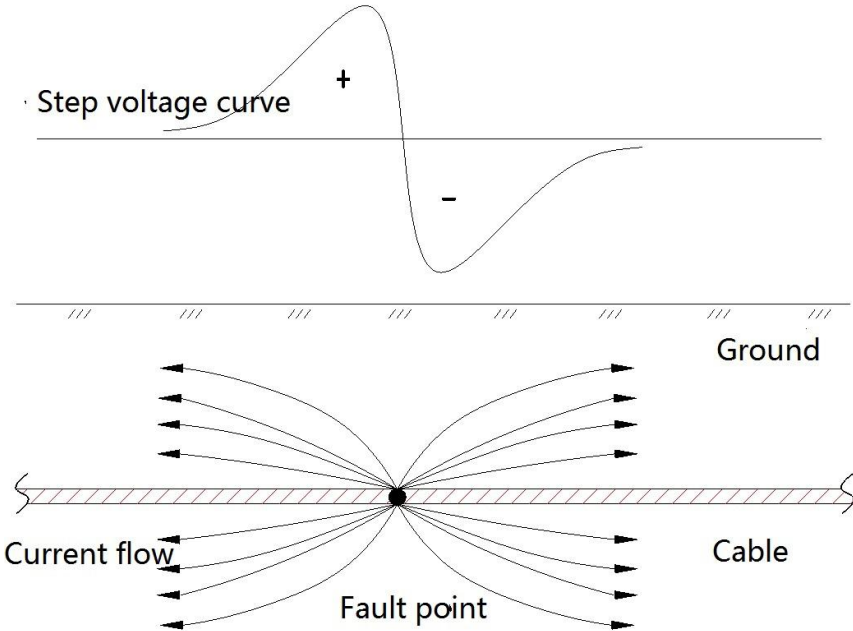

Fig.7 Principle reference

3.2 WORK MODE:

Work mode	Step voltage	Fault current	HV rod
Suitable fault	Buried cable	Laying cable through PVC	Cable laying on the holder

3.2.1 Prepare

According to the fault location results, the FLC-908D receiver and probe are carried to the detection area. The detection area is mainly selected according to the ranging results. For example, if the ranging result is 1000m, the detection area should be between 950m and 1050m.

Assemble the probe and connect the probe output wire to the signal input jack of FLC-908D(note the

color corresponding)

Insert two probes into the soil along the cable path. The orientation of the two probes must be maintained during the fixing process, with the black probe towards the source and the red probe towards the distal end. The two probes are separated by a certain distance. When the signal is weak, the distance will be extended properly, and when the signal is strong, the distance will be shortened. When the signal is very close to the fault point, the distance can be very small for accurate fixing.

If the cable is laid through PVC pipe, access the current sensor according to the need, and measure the current flowing through the exposed fault cable through the sensor to find the location of the fault point.

3.2.2 Step voltage signal pinpointing

Press the power switch for more than 1 second, power on the FLC-908D, Insert the probe into the soil near the fault cable (do not hold the probe with your hand), press the RESET key, and observe the signal waveform of the FLC-908D LCD display. If the waveform amplitude is small, the gain should be turned up. Then observe the signal waveform of the FLC-908D LCD display until the gain is adjusted properly. Observe the arrow indicating the direction of fault. Then move forward about 10 meters along the direction indicated by the arrow to continue the measurement. When the FLC-908D display signal is strong and the arrow direction is reversed, it means that the fault point has been crossed. Shorten the moving distance and look back carefully for the point where the direction of the arrow changes and the signal is strong, which is the fault point. In the pinpointing process, if the signal amplitude displayed is very small, the direction indicated by the arrow will change from left to right. The measuring point is far from the fault point, so it can continue to move forward for measurement. Or increase the signal gain over a period of time, the direction indicated by the arrow will be stable. The fixed-point process is shown in Figure 8.

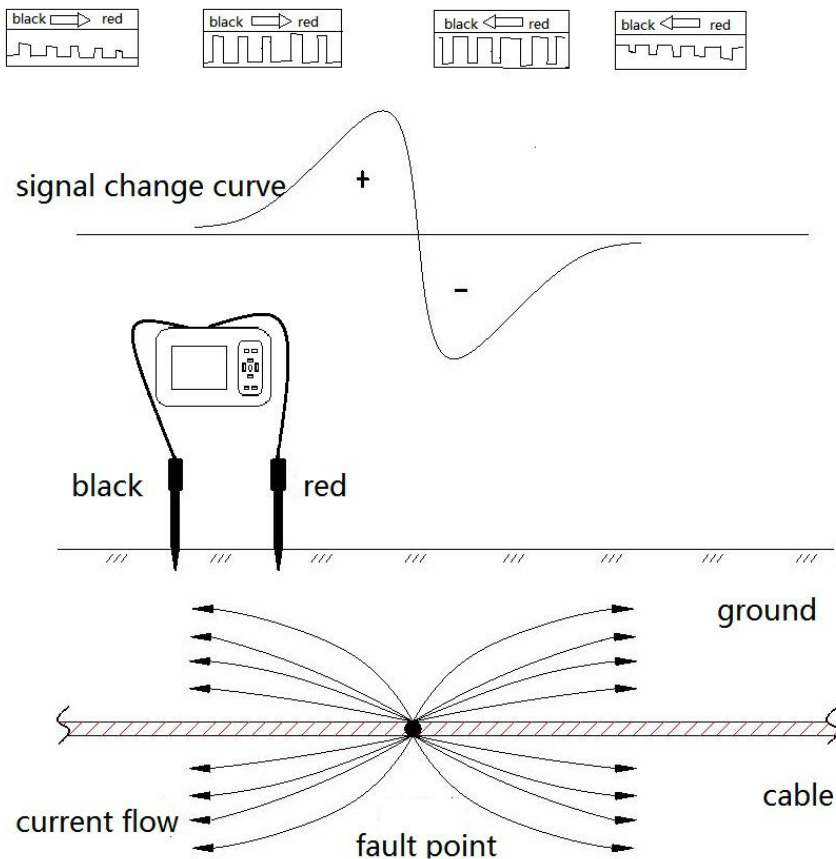

Fig.8 Step voltage pinpointing reference

3.2.3 Fault current signal pinpointing

Step voltage signal pinpointing may fail when cable is laid through PVC pipe. Now we should the fault current signal pinpointing method.

A current sensor is plugged in device to measure the current flowing through the faulty cable in the

power hole. The current is present before the position of point of failure and disappears after over the point of failure. According to this feature, the fault point can be located between two bore holes. See Figure 9.

After inserting the current sensor, press the mode plus or minus key to switch to the fault-current pinpointing mode. During measurement, the current sensor should face up and the bottom side should be as close as possible to the cable under test. The direction of the arrow of the sensor should be consistent with the direction of the cable and point to the far end.

signal variation curve

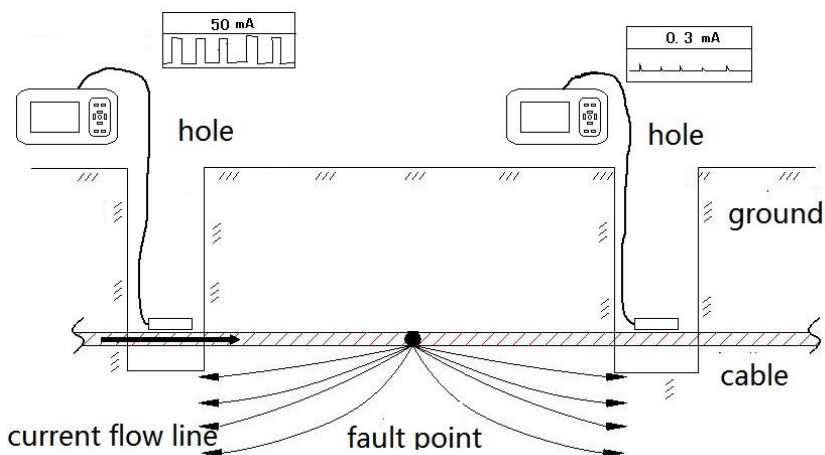

3.2.4 HV signal rod Fig.8 Step voltage pinpointing reference pinpointing

Usage: suitable for cable laid on cable support, such as cable special tunnel, comprehensive trench, shared tunnel and other corridors or tunnel structures that used to hold a large number of cables laid on cable support.

Transmitter mode setting: remove the output line of the reference FLC-900D/FLD-902D phase of the

FLC-900D/FLD-902D sheath rangefinder, and connect the output line of the fault phase to the fault sheath, then test ground wire connected to the earth. Press the DC/PULSE button to make the FLC-900D/FLD-902D work in the DC output state.

When the cable insulation layer on the support in the tunnel is damaged, the high voltage rod is used to pinpoint. According to the different voltage at different positions, the fault point of the cable insulation layer can be quickly found. After inserting the high voltage probe, press the mode plus or minus key to switch to the high pressure probe fixed point mode to start measuring pinpointing .See Figure 10.

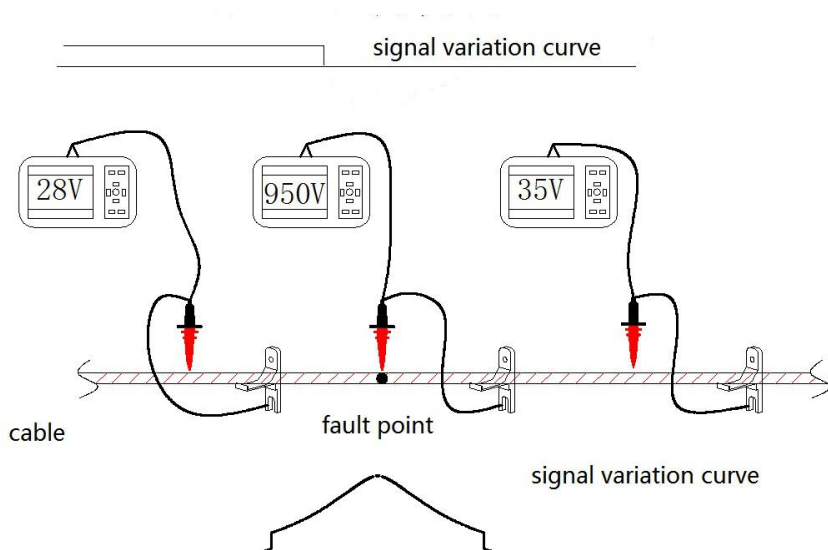

Fig.10 HV rod pinpointing section diagram

Safety warning!

The pinpointing of the high voltage rod involves the safety of people and equipment. Do not touch the cable body on the cable bracket when working!!!

NOTIFY.

1. The injection voltage using the pulsating DC method may be very high, and there may be high voltage on the cable surface (semiconductor layer) near the fault point, so it is forbidden to directly contact the cable body with the step voltage probe.
2. If there is a cement cover directly above the cable and the probe cannot be inserted, the test can be carried out in the nearby soil parallel to the cable. If the hardened ground area above the cable is large area and dry, wet the ground at the test point with water before measuring.
3. If there are multiple fault points in the protective layer, the ranging result is generally close to the most serious fault point, the point should be pinpoint and repaired first. If there is still a fault, the ranging and pinpointing process should be repeated until all the fault is repaired.
4. The output voltage of the high-voltage signal source should be lower than the withstand voltage standard of the cable sheath, generally not exceeding 10KV. Special attention should be paid especially when using the impact method.
5. For the core wire fault of three-core clad cable, if the armor at the fault point has been damaged, the step voltage method can also be used to assist the pinpointing point. However, since the armor is likely to be damaged at multiple points, the pinpointing point result is not unique, and it can only be used as an auxiliary method if other pinpointing methods (such as acoustic magnetic synchronization method)not work.

4. WARRNATY AND MAINTIAN

Device main unit and accessories are one year guarantee of free maintain, battery is one year free replacement. Beyond one year, only charge for basic component cost for maintaining.

For device breakdown by incorrect using (in the warranty) or device quality problems over warranty, we are responsible for maintaining and only charge basic component cost.

When auto power-off, unable to power on or immediately shut after power on, it's possible because low battery. Charging first and again.

If other problems, don't to maintain by yourself, contact with us first.

(manual version:V1.0)