



Tianjin Grewin Technology Co.,Ltd

Website:www.grewin-tech.com WhatsApp:+86 13072088960

Email:salesmanager@grewin-tech.com



PCLD-904P **Digital Cable Fault pin-pointer**

User Guide

©Tianjin Grewin Technology Co.,Ltd.We reserve all right in this document and in the information contained within.
Reproduction,use or disclosure to third partners without express authorization is strictly forbidden.

Address: Dong Ting Road HeXi Distr,300222 Tianjin China. Phone:+82-22-84943756

INTRODUCTION

PCLD-904P Digital Power Cable Fault Pin-pointer is an easy operation device used to pinpoint the fault point. It integrated the function of acoustic magnetic synchronization method, the step voltage method, the magnetic field strength method to make the pinpointing accuracy.

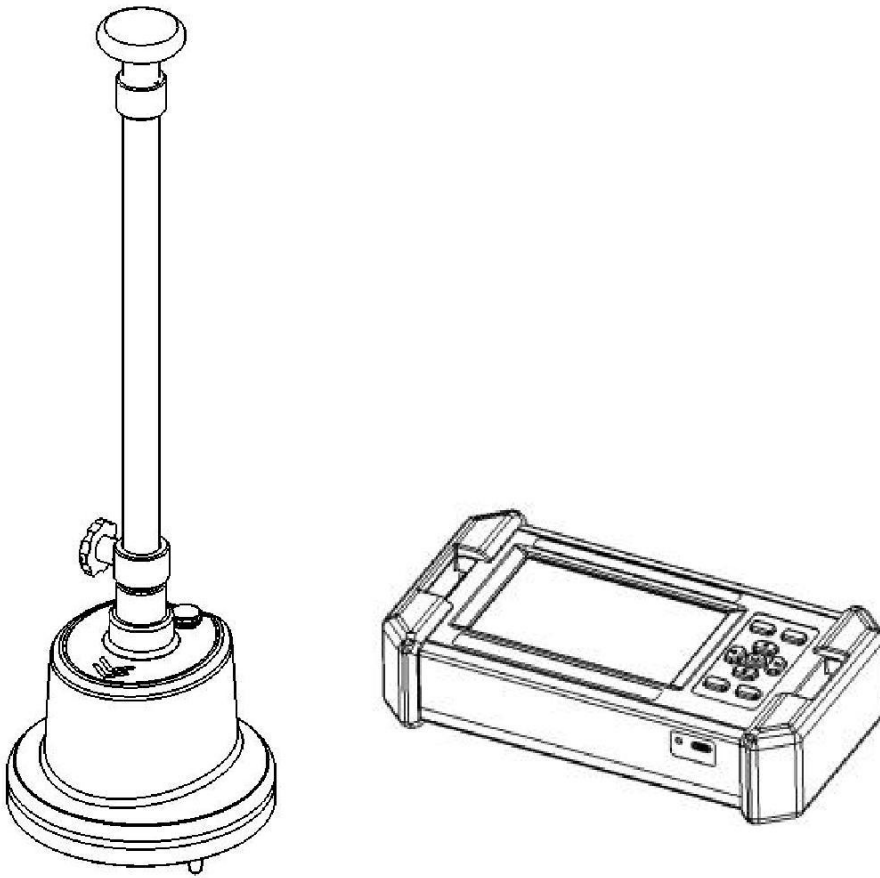

Fig.1 PCLD-904P cable pinpointing device



Tianjin Grewin Technology Co.,Ltd

Website:www.grewin-tech.com WhatsApp:+86 13072088960

Email:salesmanager@grewin-tech.com

1.DESIGN FEATHER

- Integrated the function of acoustic magnetic synchronization method
- Adopts background noise reduction tech. to reduce environment noise
- Intelligent pinpointing method to calculate the acoustic magnetic delay value
- Background noise reduction function
- Auto muting function to avoid the noise
- Electronic compass function to display the included angle between cable route direction and sensor. It's very useful for quick pinpointing
- acoustic channel filtering parameter adjustable
- Auto gain adjustment function for easy use, automatic trigger by magnetic field
- High performance anti-noise headphone
- 800x840 color LCD, luminance reach 800cd/m2 to make clear display under the sun
- Power supply management: power off automatically in 5 min. without action; Power off also when low battery voltage
- Built-in Li-ion battery



Tianjin Grewin Technology Co.,Ltd

Website:www.grewin-tech.com WhatsApp:+86 13072088960

Email:salesmanager@grewin-tech.com

2.TECH. SPECIFICATIONS

- 1) acoustic magnetic synchronous pin-pointing:
 - a) acoustic channel
 - Bandwidth:
 - all-pass: 80Hz~1500Hz
 - low-pass: 80Hz~400Hz
 - high-pass: 200Hz~1500Hz
 - band-pass: 150Hz~600Hz
 - b) Signal gain: $\geq 80\text{dB}$
 - c) Accuracy: 0.1m
- 2) Background noise reduction mode: support noise reduction, no noise reduction, adaptive noise reduction
- 3) Power supply:
 - a) Battery: built-in Li-ion battery series,3.7 V,6700mAH
 - b) Continuous work time above 9 hours
 - c) Charger: input AC220V $\pm 10\%$,50Hz;output 8.4V,output 5V/2A
- 4) Display method: 800X470 dot LCD
- 5) Size: 230mm \times 127mm \times 55mm
- 6) Weight: main unit 1kg,sensor 1.4kg
- 7) Use environment: -10 $^{\circ}\text{C}$ ~40 $^{\circ}\text{C}$,5-90% RH, elevation <4500m

PHYSICAL CHARACTERISTICS

1.STANDARD CONFIGURATION:

Main unit x1

acoustic magnetic synchronous sensors x1

High performance anti-noise earphone x1

Connection line x 1

Charger x1

2.MAIN UNIT PANEL

Details as Fig.2

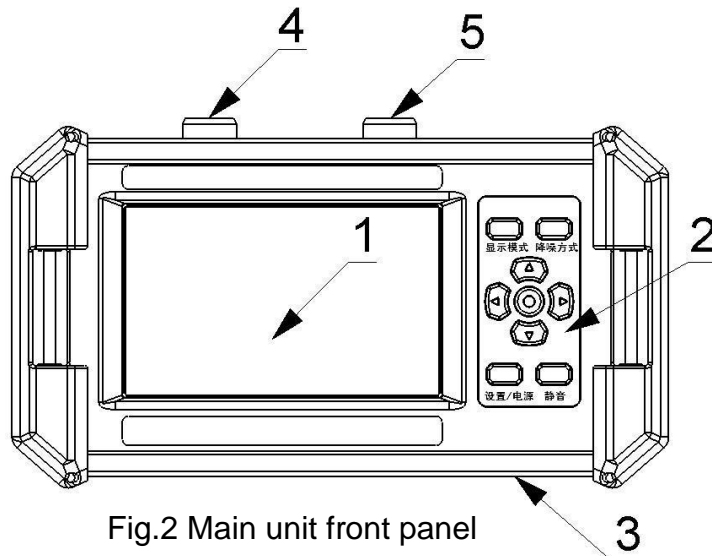

Fig.2 Main unit front panel

NO	NAME	INTRODUCTION
1	LCD	
2	KEY BOARD	<ul style="list-style-type: none"> ● [set/power]: long time press to start and short time press to enter the setting interface ● [display mode]:adjust the display mode ● [mute]:control the headphone acoustic output ● [noise reduction mode]:adjust the noise reduction mode ● [multiple function button]: [up button]&[down button]: adjust the acoustic gain [right button] &[left button]:waveform mode to adjust the cursor or adjust the magnetic field trigger value ,use the middle button to switch ● [middle button] after close the auto magnetic filed to switch the left/right button to adjust the cursor or magnetic filed trigger value
3	USB CHARGING PORT AND CHARGING INDICATION	Red light: charging Green light: charge complete
4	HEADPHONE INPUT	Connect with the headphone
5	SIGNAL INPUT	Use the signal line to connect with the sensor

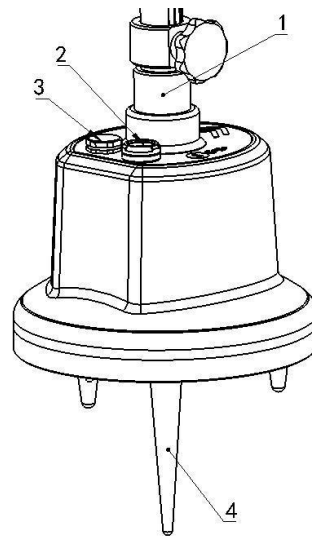

Fig.3 Sensor introduction

NO	NAME	INTRODUCTION
1	Pole	Install method: insert into the open hole and rotate the pole as one quarter turn
2	Signal port	Use to contact with the main unit with signal line
3	Breather valve	
4	Long probe	Used for the lawn or soft ground. Remove it and install in the screw hole in the bottom

OPERATION AND FUNCTION INTRODUCTION

PCLD-904P support both the acoustic-magnetic synchronization pinpointing. The acoustic-magnetic synchronization pinpointing support both intelligent pinpointing and waveform pinpointing. When use the intelligent pinpointing method, device will auto display the acoustic-magnetic delay value and when use the waveform pinpointing method, we need to make sure the cursor position and measure the delay value.

1. ACOUSTIC-MAGNETIC SYNCHRONIZATION INTERFACE AND FUNCTION

Principle:

Electromagnetic signal transmit by light speed and the time transmit from cable to the sensor could be ignore. The acoustic transmission speed is much lower only several hundred per second. So we can distinguish the faulty points distance by the time difference between magnetic signal and the acoustic signal.

There are two interfaces, intelligent pinpointing and waveform pinpointing interface when use the acoustic-magnetic pinpointing method. The intelligent pinpointing will display the acoustic-magnetic value by intelligent calculation method. It makes the pinpointing more easy and quicker, and need little experience for the user.

Device also keep a traditional waveform pinpointing interface which more suitable for the profession staffs with experience. Then the user need to measure the acoustic-magnetic delay value by the cursor. Refer below display interface:

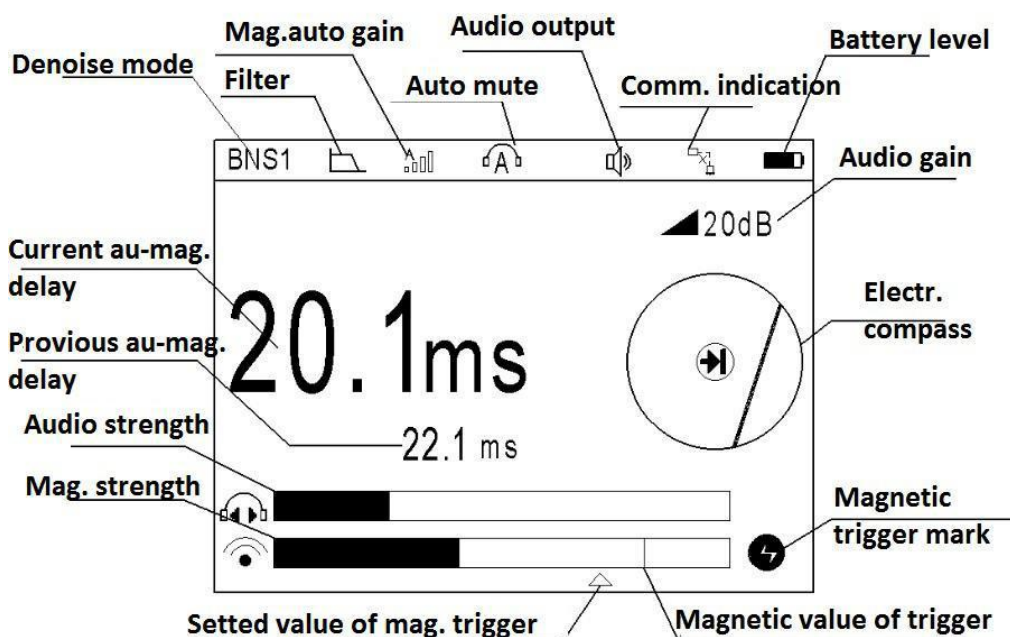

Fig.4 Intelligent pinpointing interface

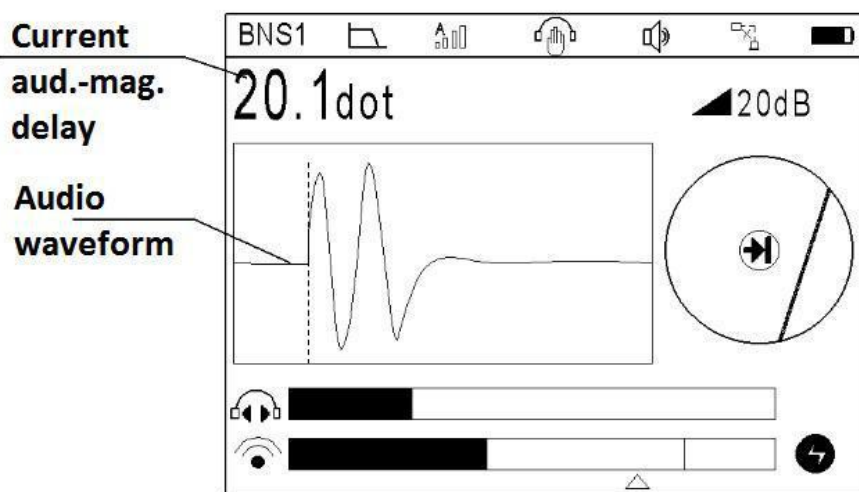













Fig.5 Waveform pinpointing interface

Name	Mark	Function	Note
Denoise mode	BNS1	Strong noise reduction	
	BNS2	Adaptive noise reduction	
	BNS OFF	No noise reduction	
Acoustic channel filter chosen		OFF: 80Hz~1.5kHz	
		LOW PASS: 80Hz~400Hz	
		HIGH PASS: 200Hz~1.5kHz	
		BAND PASS: 150Hz~600Hz	
Magnetic filed auto gain		ON	Can't support hand-adjustment if gain on
Auto mute		Auto mute on	When auto mute function on,touch the sensor handle to close the acoustic channcel and when hand remove the acoustic channel open
Audio switch		Acoustic on	Press the mute button to switch the function
		Acoutsitc off	
Communication status		Well connection for the main unit and sensor	

		Anormal connection for the main unit and sensor	
Battery level			
Magnetic trigger		Flash one time after trigger	

2. FUNCTION INTRODUCTION AND OPERATION METHOD

1) Acoustic magnetic delay and acoustic gain adjustment:

Under the intelligent pinpointing mode, it will display the acoustic magnetic delay value directly. Press **【Left button and right button】** to adjust cursor position to measure the acoustic magnetic delay value. When the magnetic filed auto close,single click the **【middle button】** to switch the left button and right button function to adjust the cursor or magnetic trigger value.

2) Auto mute indication:

This function is defaulted ON, if need, disable it from the manual.

During the pinpointing, we need to keep moving to find the suitable position. But during this process, the sensor moving will bring loud noise may hurt operator's ear. The auto mute function will make the headphone mute when the hand touch the sensor handle, and when the hand leave the sensor the acoustic will be auto open again.

3) Background denoise mode (BNS) Total three modes

Mode	Introduction	Feather
BNS1 Strong noise reduction mode	Compare with near discharge waveform shape and distinguish whether it's a real discharge sound. If so,device will produce the sound,if not the device will mute. To use this mode, it needs 2~3 discharge periods in same position to distinguish the position	Suitable for most of the sites. Feather: Sound could be heard when the position is in the faulty point Need 2~3 discharge periods in same position
BNS2: Adaptive noise reduction mode	The noise is random but the discharge sound is repeat. Device will extract the discharge sound during several discharge periods. And to make it possible to pinpoint the faulty point in even noise site. To stay longer in the site and more discharge triggers,the more obvious discharge sound and more correct delay value. When auto mute function is on,device will re-extract the discharge characteristic and environment characteristic. If the 【 MUTE 】 button off,it needed to reset by hand to re-extract the discharge characteristic and environment characteristic.	Suitable for very noise environment. Feather: The more discharge trigger the more obvious discharge sound.



Tianjin Grewin Technology Co.,Ltd

Website:www.grewin-tech.com WhatsApp:+86 13072088960

Email:salesmanager@grewin-tech.com

BNS OFF: no noise reduction	The sound extract from the sensor directly output by earphone and no noise reduction	Original sound signal
-----------------------------	--	-----------------------





4) Acoustic channel filter setting

The device factory default setting is low band.

Faulty point discharge acoustic frequency is great effected by propagation medium and propagation distance. The quicker acoustic waveform propagation and the smaller the distance from the source, the less decay for the waveform high frequency.

In the site, the hard cover, such as the cement, slab stone, make waveform higher transmit speed and more high frequency waveform. The soft cover ,such as the sand or soil, will make the high frequency of the discharge sound decay and leave low frequency.

So our device supports below four filtering mode.

Filter parameter	Function introduction
 OFF	OFF: bandwidth 100Hz~1.5kHz It offer the max. work bandwidth, it is used in the environment with little disturb.
 LOW PASS	LOW PASS: bandwidth 100Hz~400Hz It is suitable to test the far faulty point and the cover is softly dirty or sand. But don't reduce low frequency disturb signal
 HIGH PASS	HIGH PASS: bandwidth 200Hz~1.5kHz It is suitable to used in the hard road or the faulty point is near
 BAND PASS	BAND PASS: bandwidth 150Hz~600Hz Eclectic mode of high pass and low pass

5) Magnetic field auto gain

Device supports auto magnetic field trigger value and auto adjust the trigger signal.

If need adjust it by hand, refer below steps:

- Enter the setting interface and close the magnetic auto gain function and exist.
- Press the **【middle button】** and switch it to the mode of adjusting magnetic field setting value, and then change the magnetic strength position and made this this position a little lower than the real-time magnetic max value

6) Electric compass

It is used to indicate the direction angle of underground cable route direction and sensor direction.

When find the sensor is deflected, we need to adjust the sensor direction and make the sensor arrow

Address: Dong Ting Road HeXi Distr,300222 Tianjin China. Phone:+82-22-84943756

point to the cable laying direction.

Refer below:

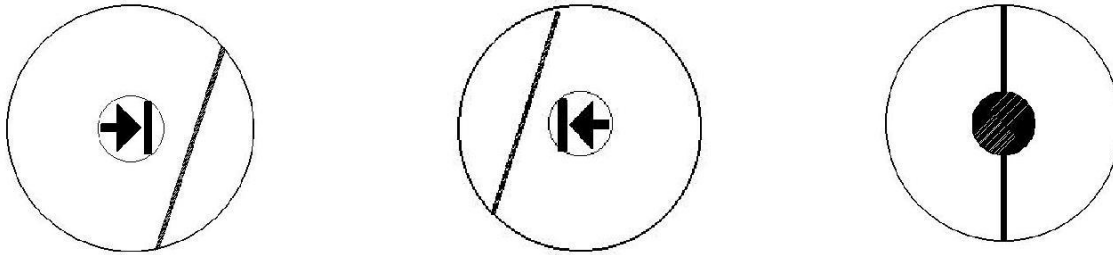

Fig.6 A B C
 A: cable is in the left of the sensor and it is about 25 ° angle against sensor
 B: cable is in the right of the sensor and it is about 25 ° angle against sensor
 C: cable is right above the sensor

3. PARAMETER SETTING

Setting interface as below fig.7

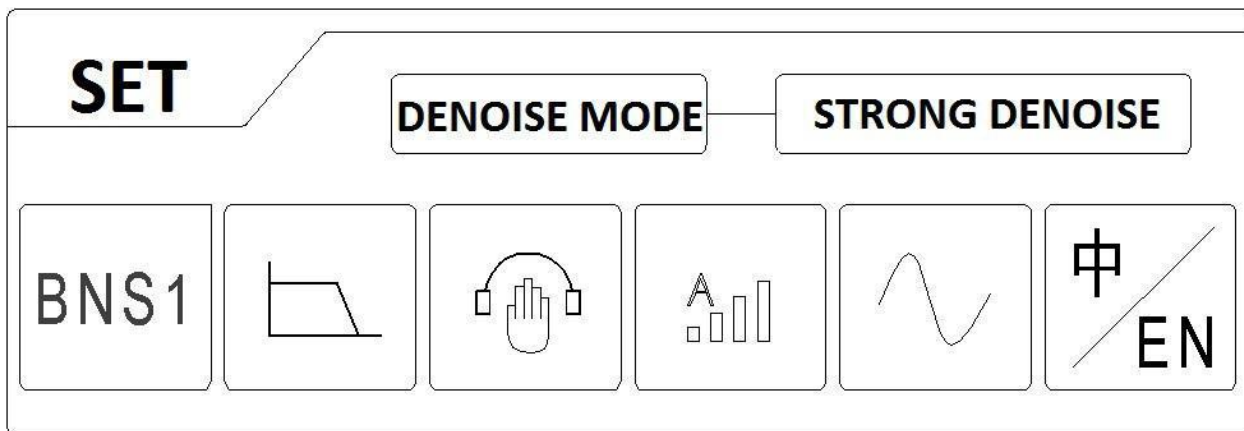

Fig.7 Setting interface

Operation steps:

- 1) Single click **【SET/POWER】** button to enter the setting interface
- 2) Single click **【Left button】** to modify the parameter
- 3) Single click **【middle button】** button to exist the setting interface and save the parameter automatically.

ACOUSTIC MAGNETIC SYNCHRONOUS PINPOINTING

1. WORKING PRICIPLE

Acoustic magnetic synchronous pinpointing method is a accuracy and based on traditional audio magnetic pin-pointing method but with improvement.

Traditional method use the high voltage generator to impact the fault cable by PCLD high voltage to make the fault point breakdown and discharge. The mechanical vibration from this delivered to the earth and be collected by the sensor, which is synchronous with the special sound..

The traditional method only use the earphone to monitor and use the meter pointer to help to distinguish the discharging sound. Because this discharging sound is fleeting and difficult to distinguish from the environment noise, it common requires rich experience user.

To modify the traditional method, we now use acoustic magnetic synchronous pinpointing method. Because the magnetic transmission velocity is much quicker than the acoustic transmission velocity, It's definitive sample to find the faulty point by testing the time difference between magnetic signal and audio signal. Keep moving the sensor to find the point with min. time difference, and this will be the fault point.

Please also notice, because there's no exact data for the acoustic velocity in the cable and have no exact data of the cable depth, it is difficult to calculate the distance between the sensor and the faulty point.

2. HV GENERATOR WIRING METHOD

To use this method, we need a HV signal generator and work in period discharging mode.

1) Phase -sheath connection

For the phase-earth fault, phase-phase grounding fault and break fault, we could use the phase-sheath connection method which is with smaller propagation-attenuation for the fault point discharging. Fig.9 show the connection of generator and the cable sheath :

Connect the output line of generator with cable fault phase,and ground with the cable metal sheath.

<1.High voltage impulse generator

<2.Ground

<3.High voltage output

<4.Fault phase

<5.Metal sheath

<6.Grounding grid

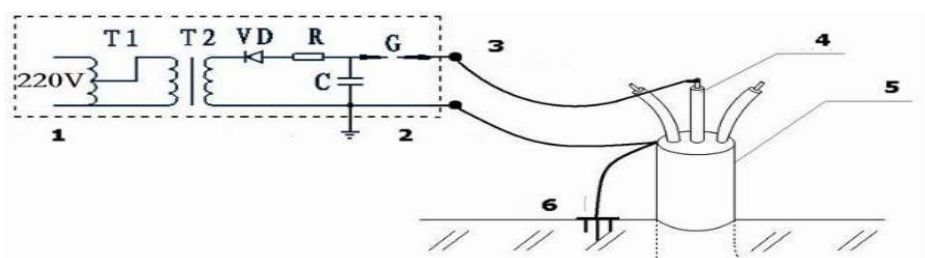

Fig.8 Phase-sheath connection

2) Phase-phase connection:

For the phase-phase fault without grounding, we could use this method to in.Fig.10 shows: Connect the high voltage output line and ground with the two faulty phases. One phase need to do safety grounding.

- <1.High voltage impulse generator
- <2.Ground
- <3.High voltage output
- <4.Fault phases
- <5.Safety ground
- <6.Grounding grid

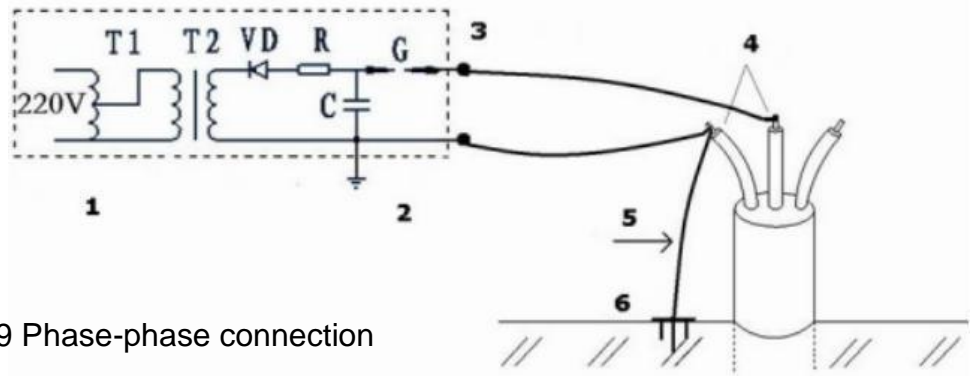

Fig.9 Phase-phase connection

3) Open circuit line fault connection:

For the single phase open circuit fault without grounding, connection as fig.10

- <1.High voltage impulse generator
- <2.protective grounding
- <3.Good phase

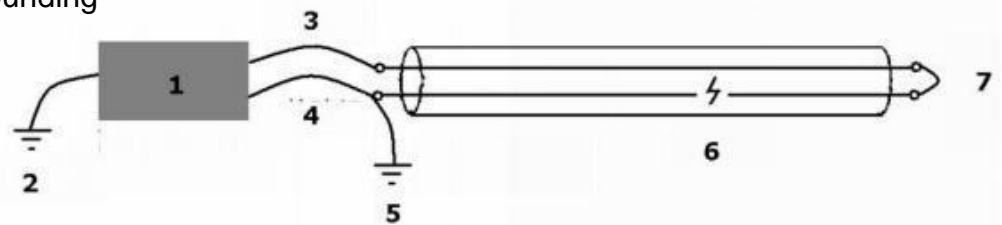

Fig.10 Open circuit fault connection method

- <4.Fault phase
- <5.Safety grounding
- <6.Fault point <7.Far-end short circuit

Connect the generator HV output line and grounding line with one good phase and one fault phase of the cable. In the cable far end, we need to make the two phases short circuit.



3. PINPOINTING STEPS

1) Connect the sensor and the earphone

Connect the sensor in the sensor port and insert the earphone with the earphone interface, and set the work mode as INTELLIGENT PINPOINTING or WAVEFORM PINPOINTING

2) Choose the pinpointing zone

Before pinpointing, please first detect the target cable route, and marked. More clearer route, easier pinpointing. According the measurement result, consider the cable margin and terrain, the pinpointing zone should be +/-50m of the pre-locating range.

In the chosen zone, put the sensor on the ground above the cable and direction should point to the cable laying direction. Use the earphone to monitor and pinpoint.

3) Adjust the magnetic gain:

After generator periodic discharging, adjust the Mag. Gain to make the indicator light synchronous

with the discharging. * Auto gain  open, it is no needed to adjust by hand.

4) Adjust the acoustic gain:

After adjust the synchronous gain, adjust the acoustic gain.

When the Synchronous indicator bright, the acoustic signal synchronous sampling one time and update the waveform.

Adjust the acoustic gain, make the acoustic waveform large without distortion.* In the intelligent pinpointing interface the acoustic signal strength should be between 40% and 90%.

The acoustic signal is keeping changing and if need to check the real waveform, we need keep adjusting gain. According the experience, acoustic signal gain is large will be ok, no need to adjust at any time.

5) Find the fault point:

Move the sensor in 0.5~2m interval. If did not find the typical waveform as fig.4,pls keep move until this waveform appear and is stabilization. Now there will be special crack sound when the indicator light flash.

6) Acoustic magnetic delay measurement and pinpointing

After see the discharging waveform, under the waveform display mode to press the button】 to adjust the cursor to the beginning point of the acoustic waveform.

And now the delay value can be seen a mark of the fault points distance. But as it's difficult to know the acoustic propagation velocity and cable depth so can't calculate the exact distance between sensor and point. 【Left and right

***IF THE CURSOR IN OTHER POSITION,THE DELAY VALUE IS NOT USEFULL.**

Keep moving the sensor and check the delay value until find the position with min.delay time, and the point is under this position. The deviation is no more than 0.2m.Refer below Fig.11

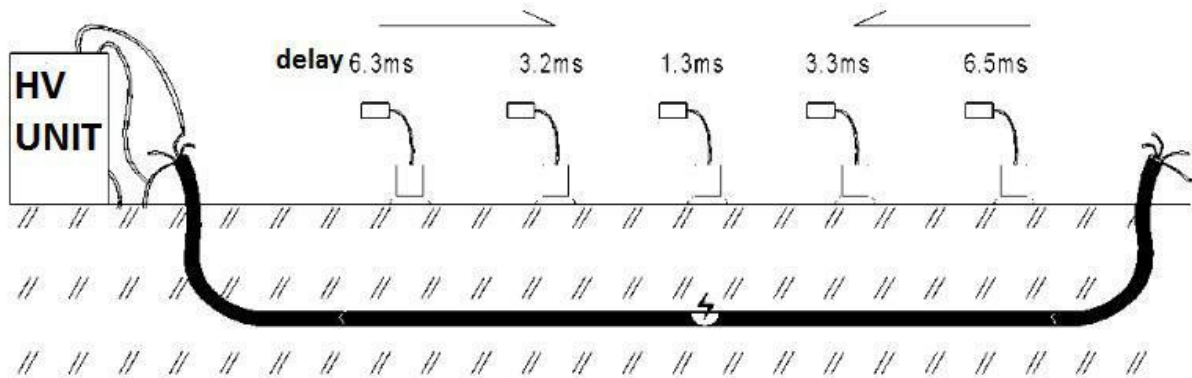

Fig.12 acoustic magnetic synchronization pinpointing

7) Use the cable position to do route tracing

When using, make sure the sensor direction points to the cable laying direction and the pinpointing heading direction.

If the cable position indication is LEFT-ARROW, the cable is in the left of the sensor.

If RIGHT-ARROW, the cable is in the right of the sensor.

If ROUND POINT, the cable is just below the sensor.

8) *notice:

Please don't put the sensor on the cable as the large current discharge will cause the vibration of the whole cable.



Tianjin Grewin Technology Co.,Ltd

Website:www.grewin-tech.com WhatsApp:+86 13072088960

Email:salesmanager@grewin-tech.com

CHARGE AND WARRANTY

1.CHARGE

When the battery level is low, user should to charge or change battery. Or when the level is too low, the device will power off.

Insert the charger output port into the device charging port. Standard power is 220V.

To insert the charger into the device USB port.

The indicating light on the charge indicate the charge status:Red indication means continue,the green light means finished.The charge time is about 4 hours,it's not strict and will not damage the battery.

It's better to charge after the power run out.

2.WARRANTY

If device quality problem,the device main unit,accessories and charger is 3 years warranty. Battery is 1 year warranty.

If broken by error operation and over the warranty period,we will maintain and only charge for the basic cost.

If below problems,try below steps first:

Can't power on: check battery level

Auto power off:Check device battery or restart device again

Auto power off at once after power on: check the battery level If still problem or other problems contact us at once.

