



Tianjin Gerui Wen Technology Co., Ltd.

Web: <http://www.grewin-tech.com/>

E-mail: salesmanager@grewin-tech.com

Тел: 86-22-84943756

WhatsApp: +86-130720888960

Адрес: 300222 Dingting Road, Hexi, Tianjin, China



Миниатюрный ламинированный трансформатор напряжения





Миниатюрный ламинированный трансформатор напряжения

OUTLINE DRAWINGS

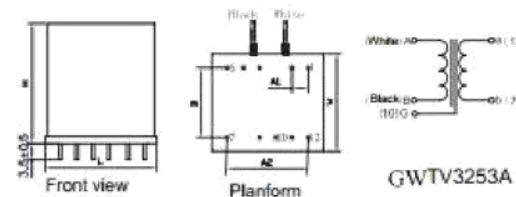
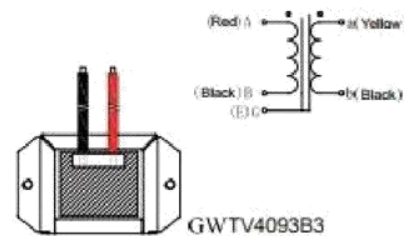
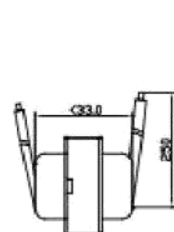
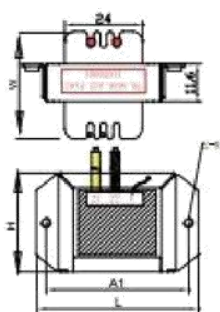
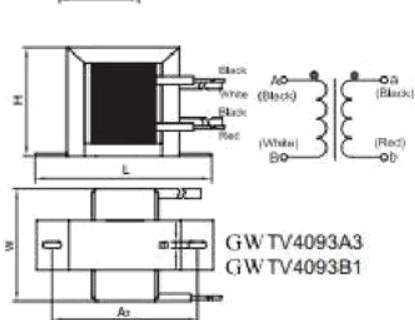
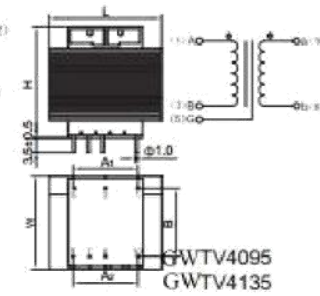
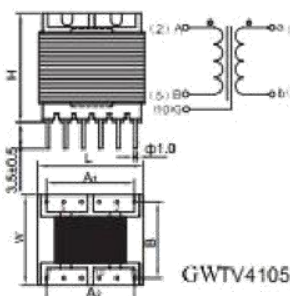
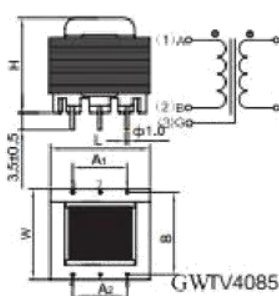
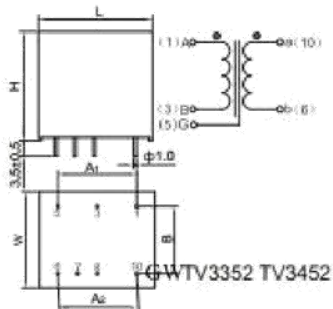
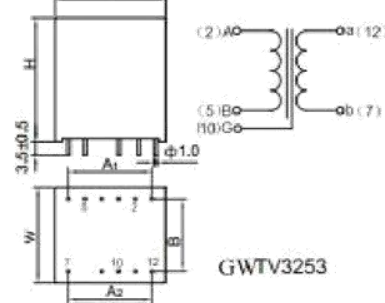
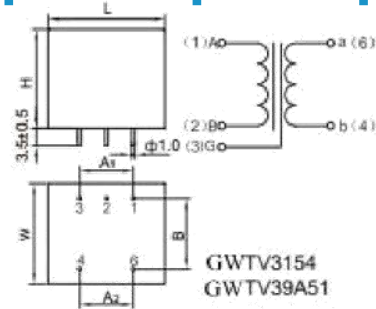
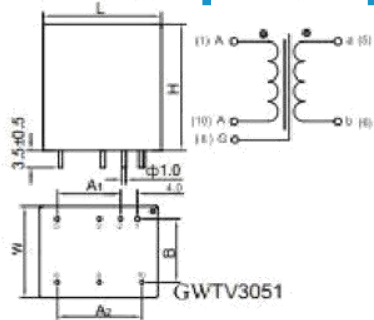

Миниатюрный ламинированный сердечник

Part Number	Rated Input/Output	Frequency (Hz)	Excitation Current (mA)	Accuracy Class	Outline Dimensions (mm)
GWTV3051	Input: 100V,220V,240V Output:0.1V,0.333V...3.53V...7.07V	50 to 400	≤0.5	0.5	L-W-H 28.5-22.0-30.2
GWTV3051A (metal shell)	Input: 100V,220V,240V Output:0.1V,0.333V...3.53V...7.07V	50 to 400	≤0.5	0.5	L-W-H 28.5-22.0-30.5
GWTV3154	Input: 100V,220V,240V,400V Output:0.1V,0.333V...3.53V...7.07V	50 to 400	≤0.5	0.2 0.5	L-W-H 31.5-28.5-30.0
GWTV3154A (metal shell)	Input: 100V,220V,240V,400V Output:0.1V,0.333V...3.53V...7.07V	50 to 400	≤0.5	0.2 0.5	L-W-H 31.5-28.5-29.0
GWTV39A51	Input: 100V,220V,240V,400V Output:0.1V,0.333V...3.53V...7.07V	50 to 400	≤0.5	0.2 0.5	L-W-H 35-32.0-32
GWTV3253	Input: 100V,220,240V,400V, Output:0.1V,0.333V...3.53V...7.07V	50 to 400	≤0.5	0.2 0.5	L-W-H 33.0-28.5-37.0
GWTV3253A (metal shell)	Input: 100V,220,240V,400V, Output:0.1V,0.333V...3.53V...7.07V	50 to 400	≤0.5	0.2 0.5	L-W-H 33.8-29.5-37.2
GWTV3352	Input: 100V,220,240V,400V, Output:0.1V,0.333V...3.53V...7.07V	50 to 400	≤0.5	0.2 0.5	L-W-H 38.0-33.0-37.0



Миниатюрный ламинированный трансформатор напряжения

GWTV3452	Input: 220,240V,380V,600V Output:0.1V,0.333V...3.53V...7.07V	50 to 400	≤0.5	0.2 0.5	L-W-H 41.5-35.5-39.0
GWTV4085	Input: 100V,220V,240V,400V Output:0.1V,0.333V...3.53V...7.07V	50 to 400	≤0.5	0.2 0.5	L-W-H 28.3-25.3-27.0
GWTV4105	Input: 100V,220,240V,400V, Output:0.1V,0.333V...3.53V...7.07V	50 to 400	≤0.5	0.2 0.5	L-W-H 30.3-25.3-31.0
GWTV4095	Input: 100V,220,240V,400V, Output:0.1V,0.333V...3.53V...7.07V	50 to 400	≤0.5	0.2 0.5	L-W-H 35.3-30.3-34.0
GWTV4135	Input: 220,240V,380V,600V Output:0.1V,0.333V...3.53V...7.07V	50 to 400	≤0.5	0.2 0.5	L-W-H 38.5-32.5-37.0
GWTV4093A3	Input: 57.7V,100V,120V,150V, Output:0.1V,0.333V...3.53V...7.07V	50 to 400	≤0.5	0.2 0.5	L-W-H 50.0-33.0-37.0
GWTV4093B3	Input: 57.7V,100V,120V,150V, Output:0.1V,0.333V...3.53V...7.07V	50 to 400	≤0.5	0.2 0.5	L-W-H 50-33-30.0
GWTV4093B1	Input: 100V,220,240V,380V,400V Output:0.1V,0.333V...3.53V...7.07V	50 to 400	≤0.5	0.2 0.5	L-W-H 56.0-35.0-31.3

Миниатюрный кольцевой сердечник

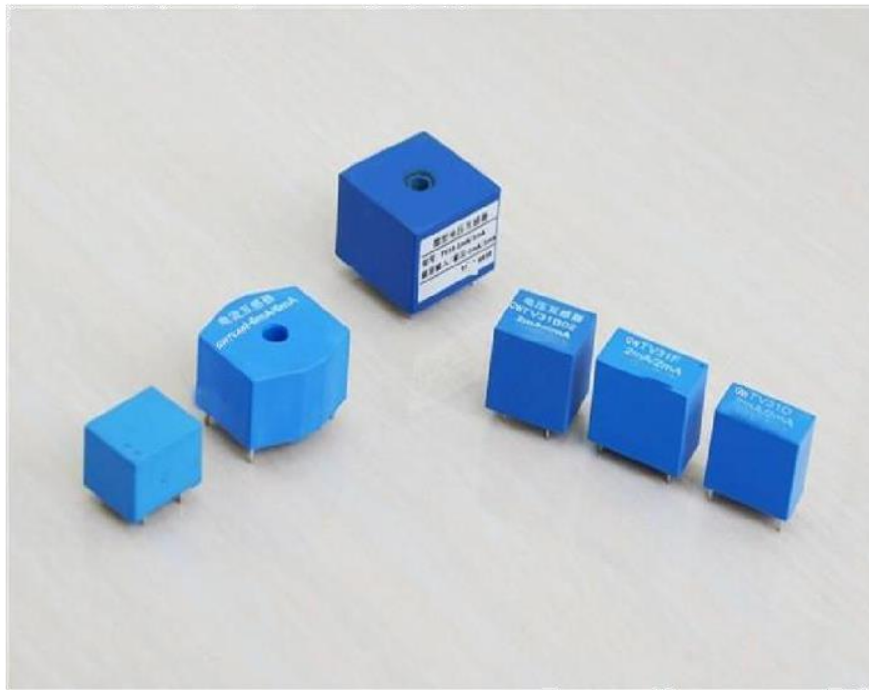

■ Typical Temperature Dependence of Phase and Amplitude Errors GWTV52-120V/3.53V

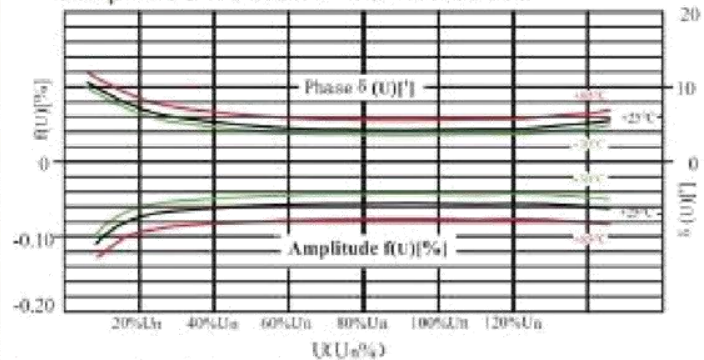

■ PART NUMBERS

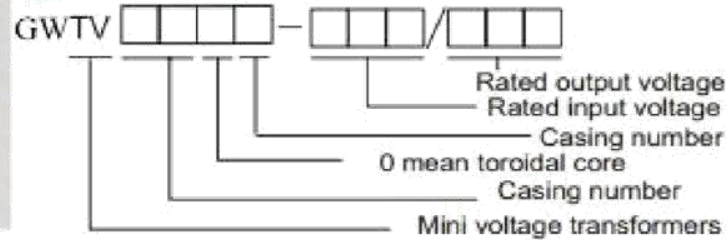

Малый кольцевой трансформатор напряжения

OUTLINE DRAWINGS

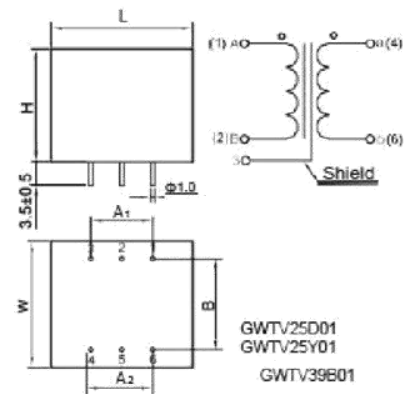
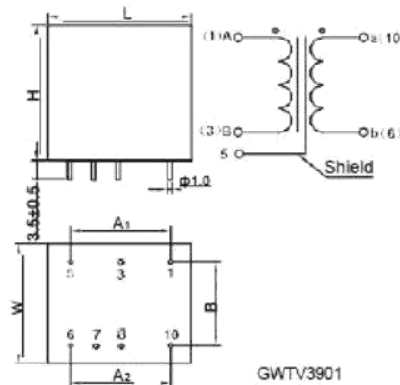
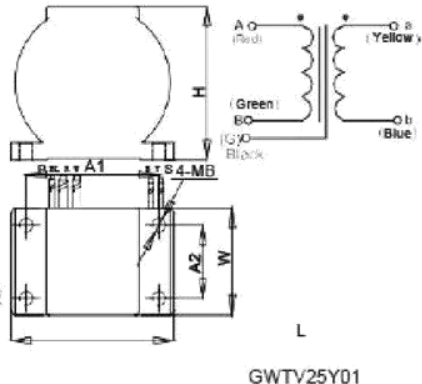
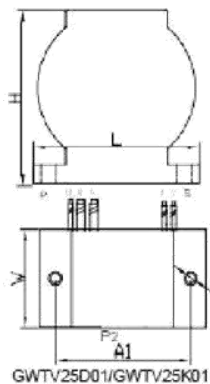
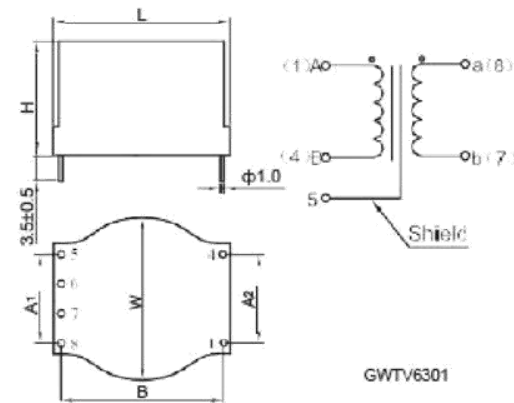
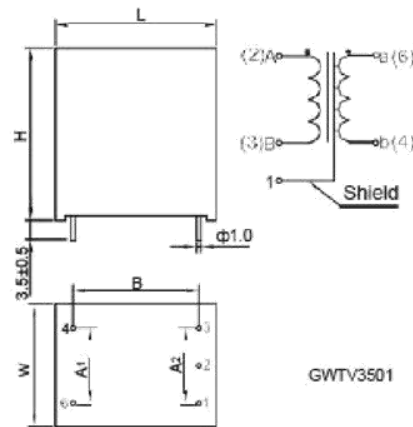
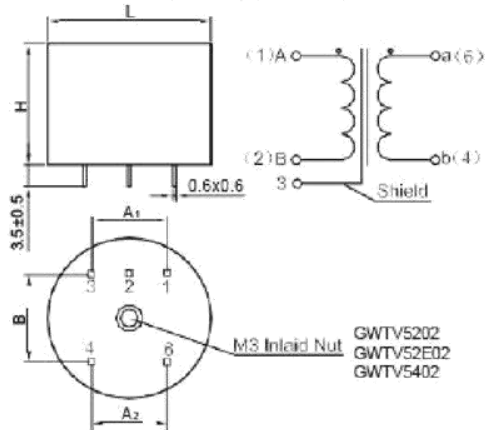

GWTV25K01

Миниатюрный кольцевой сердечник

Part Number	Rated input/output	Frequency (Hz)	Excitation Current (mA)	Accuracy Class	Outline Dimensions (mm)
GWTV5202	Input: 57.7V, 100V, 120V, 200V Output: 100mV--7.07V (Optional)	50 to 400	≤0.5	0.1	OD-H 32.0-26.0
GWTV52D02	Input: 57.7V, 100V, 120V, 200V Output: 100mV--7.07V (Optional)	50 to 400	≤0.5	0.1	OD-H 31.0-30.0
GWTV5402	Input: 150V, 200, 220V, 300V Output: 100mV--7.07V (Optional)	50 to 400	≤0.5	0.1	OD-H 37.4-28.0
GWTV3501	Input: 57.7V, 100V, 120V, 200V Output: 100mV--7.07V (Optional)	50 to 400	≤0.5	0.1	L-W-H 32.0-25.0-34.0
GWTV39B01	Input: 57.7V, 100V, 120V, 200V Output: 100mV--7.07V (Optional)	50 to 400	≤0.5	0.1	L-W-H 35.0-32.0-28.5
GWTV3901	Input: 150V, 220V, 300V Output: 100mV--7.07V (Optional)	50 to 400	≤0.5	0.1	L-W-H 36.5-31.0-35.0
GWTV6301	Input: 300V, 380V, 500V Output: 100mV--7.07V (Optional)	50 to 400	≤0.5	0.1	L-W-H 47.0-44.0-31.0
GWTV25D01	Input: 150V, 220V, 300V, 380V Output: 0.1V, 0.333V...3.53V...7.07V	50 to 400	≤0.5	0.1	L-W-H 50.0-26-46.0
GWTV25K01	Input: 150V, 220V, 300V, 380V Output: 0.1V, 0.333V...3.53V...7.07V	50 to 400	≤0.5	0.1	L-W-H 45.5-31-46.0
GWTV25Y01	Input: 150V, 220V, 300V, 380V Output: 0.1V, 0.333V...3.53V...7.07V	50 to 400	≤0.5	0.1	L-W-H 49-32.0-46.0